

 **LAPLISS**
la tua tenda plissettata *pro*

Istruzioni Montaggio **Vertigo**

Lucie & Francesco
DESIGNER

PROTETTI CON STILE

anche da sguardi indiscreti



Grazie per aver scelto
un prodotto DFM



Per problemi in sede di montaggio potete
contattare il ns. call center al numero
+39 06 9069423 oppure visitare il nostro
sito, www.dfmitalia.com, sezione supporto,
domande frequenti.

Per ulteriori info scrivetece a:
info@dfmitalia.com



PULIRE IL VETRO

**SALVIETTINA
3M IN
DOTAZIONE**

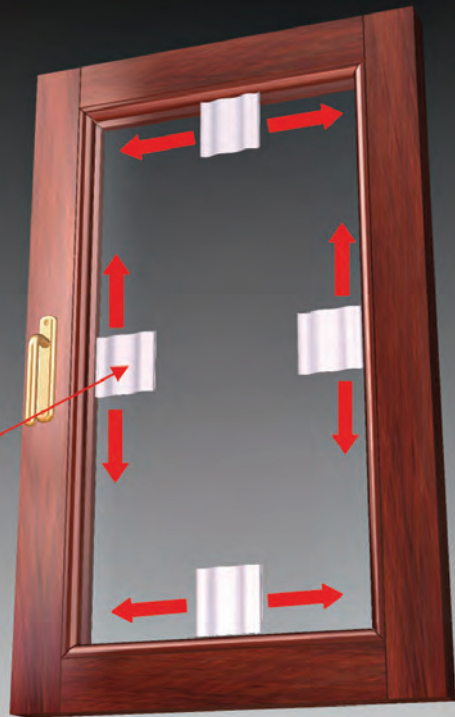

**FISSARE IL FILM
ADESIVO**

FILM ADESIVO

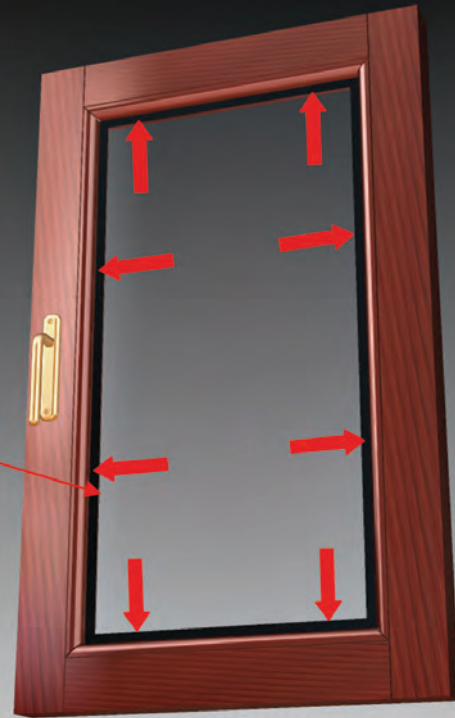

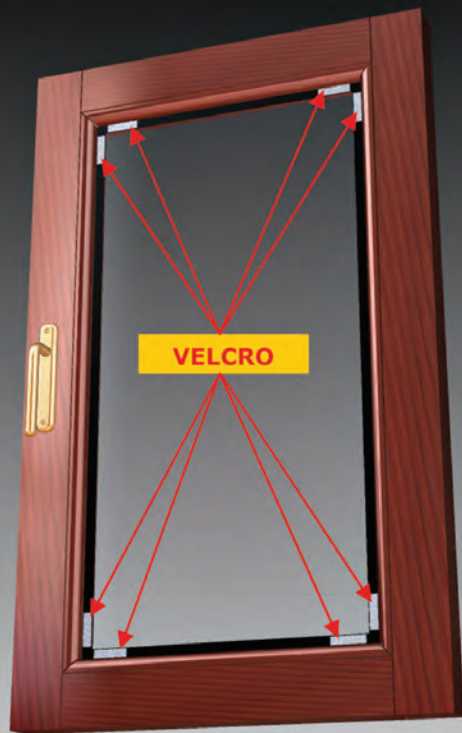

**FISSARE
IL VELCRO**

**ALLINEARE IL
PACCHETTO
TESSUTO AI
MARGINI DEL
VETRO**

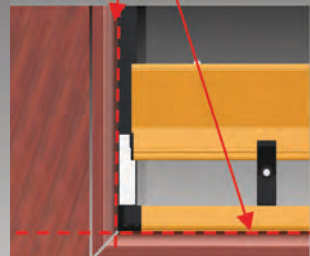

**FISSARE IL
PACCHETTO
TESSUTO**

**ALLINEARE IL
PACCHETTO
TESSUTO AI
MARGINI DEL
VETRO**

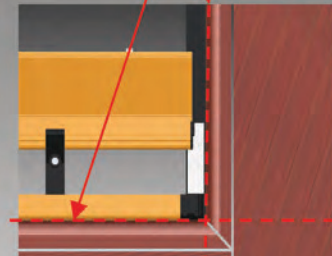

DIMA DI FISSAGGIO

VELCRO

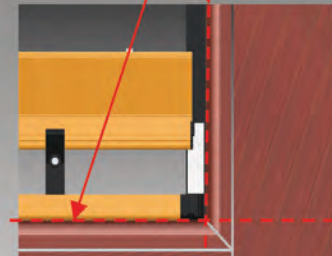
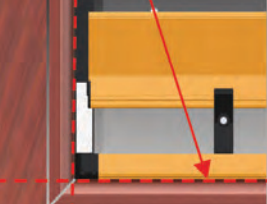

REGOLAZIONE ANGOLARI

DOPO LA
REGOLAZIONE
SERRARE LE
VITI

DOPO LA
REGOLAZIONE
SERRARE LE
VITI

ALLINEARE
L'ANGOLARE
DX E SX AI
MARGINI DEL
VETRO

FISSARE IL MONTANTE DI PARTENZA

ALLINEARE IL
MONTANTE DI
PARTENZA CON I
MARGINI DEL
VETRO

ALLINEARE IL
MONTANTE DI
PARTENZA CON I
MARGINI DEL
VETRO

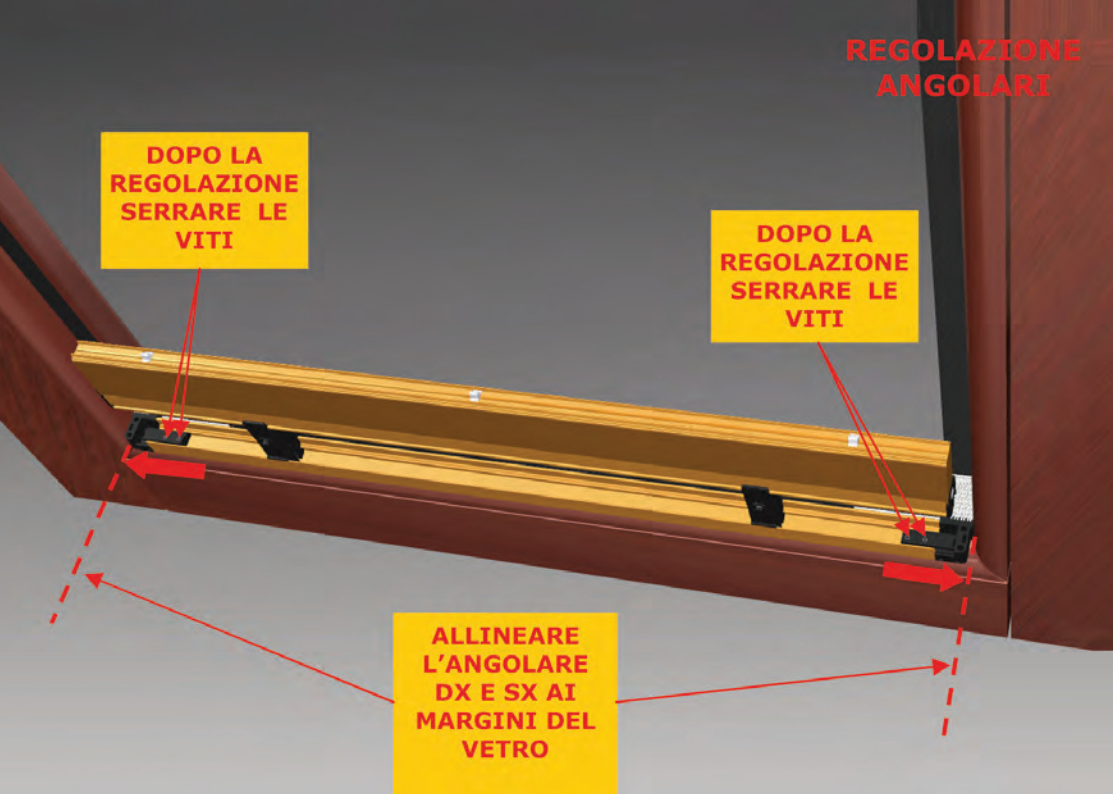

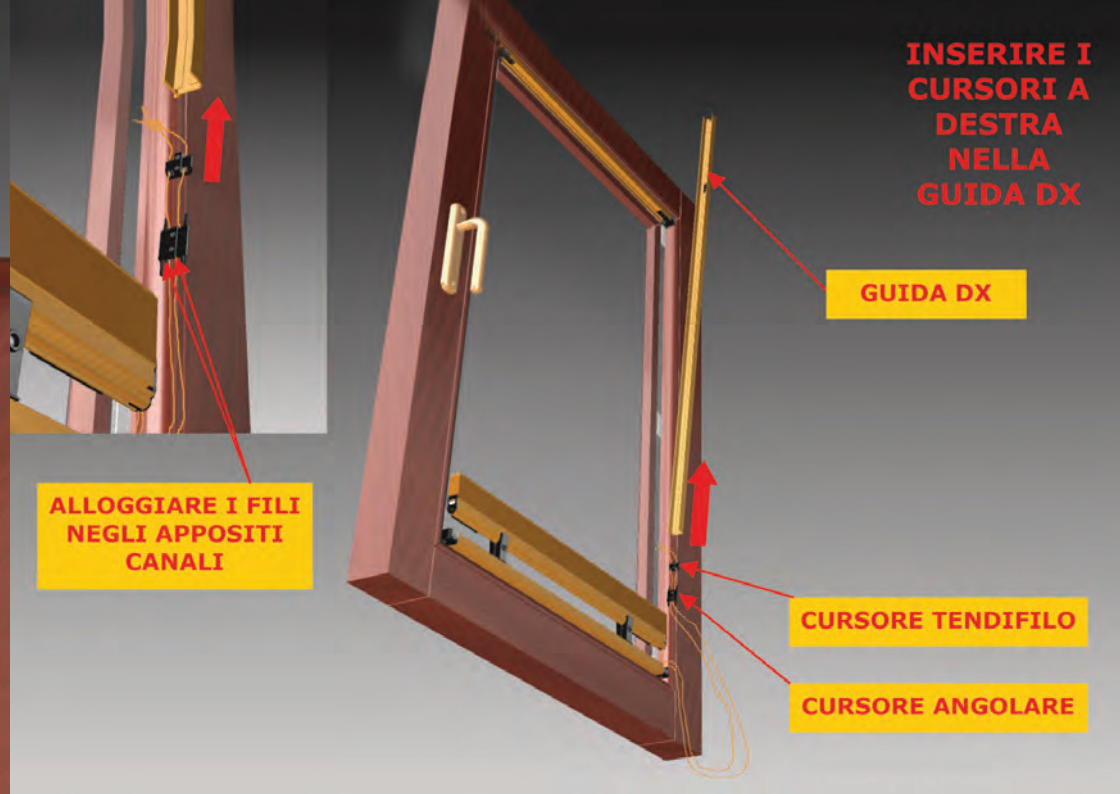
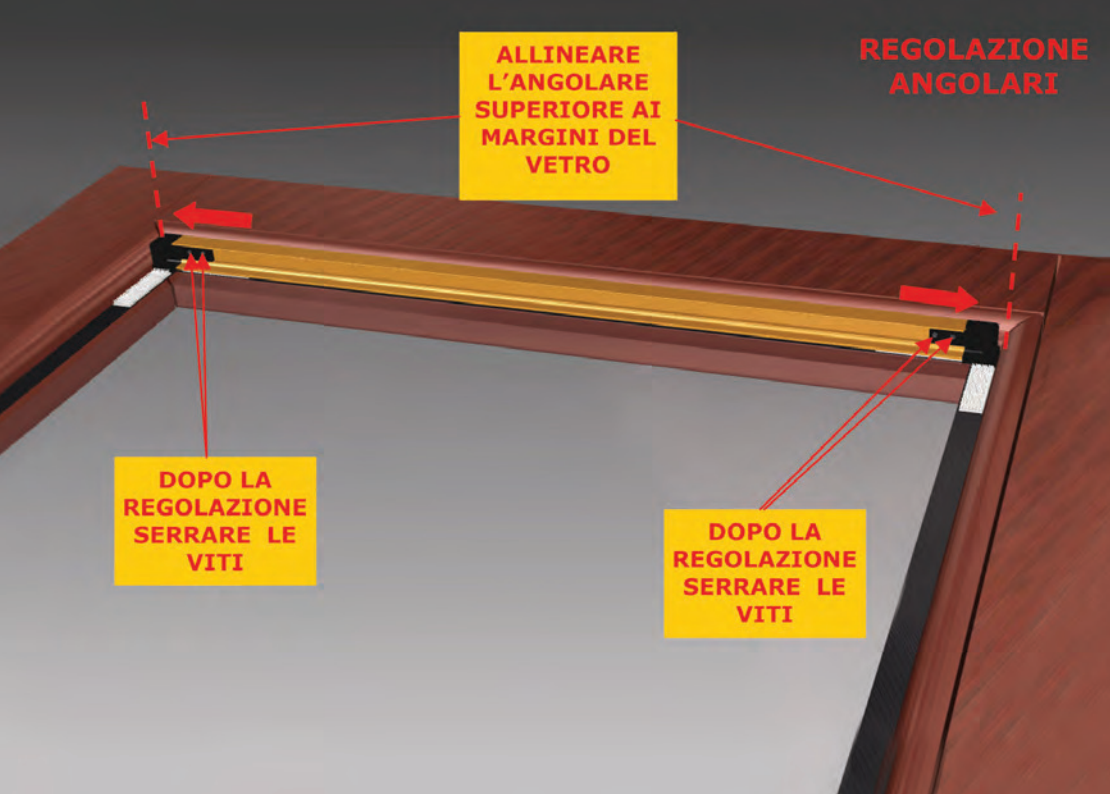

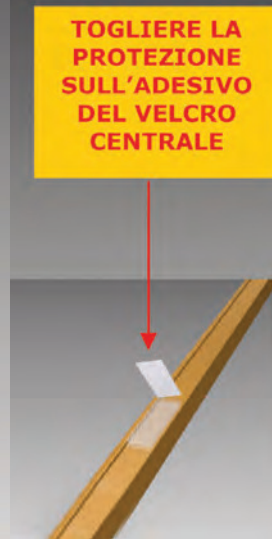
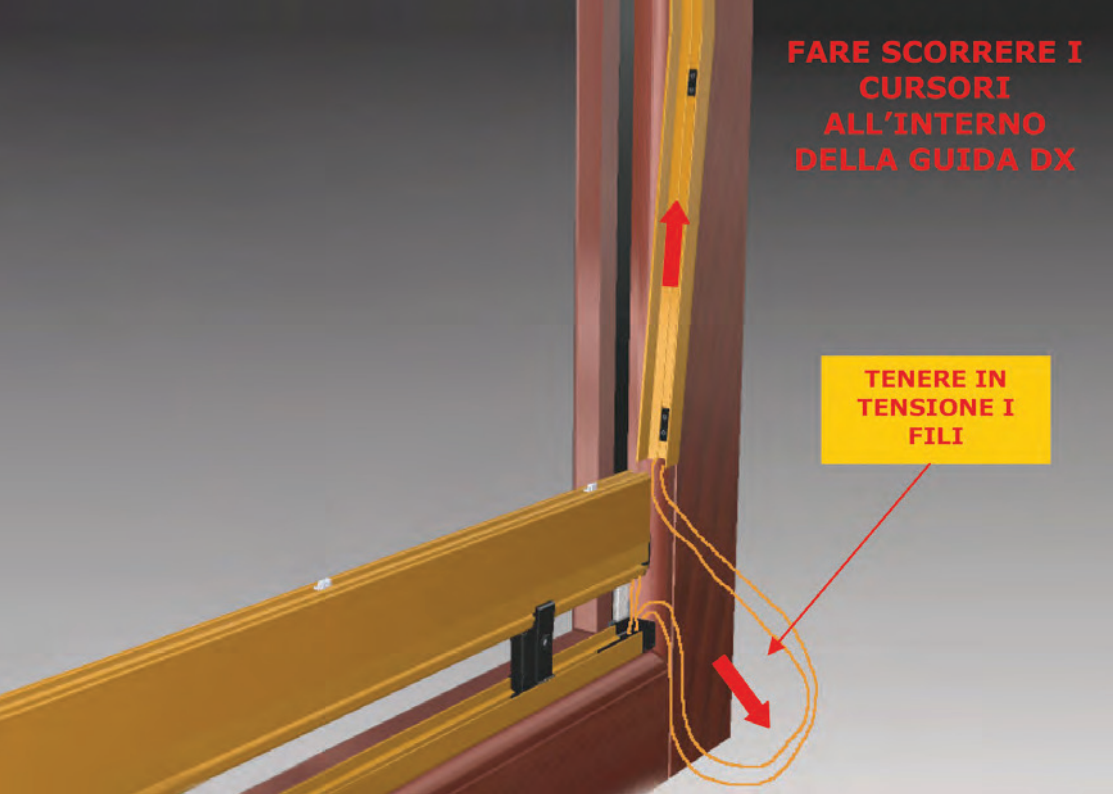

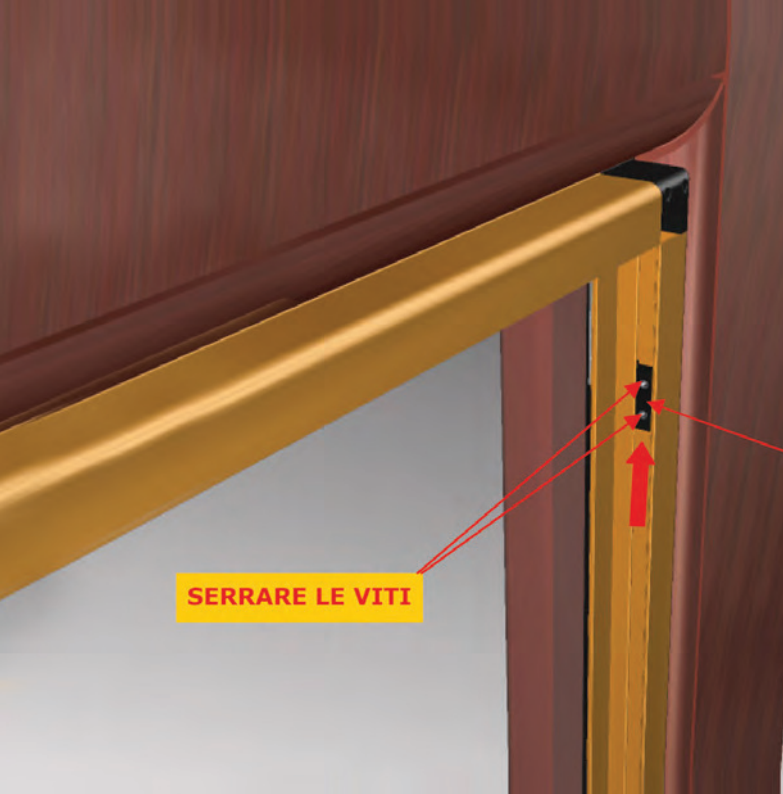

SERRARE LE VITI

CURSORE ANGOLARE

INSERIRE IL
CURSORE
ANGOLARE

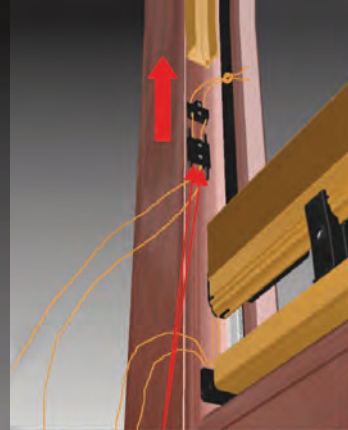

ALLOGGIARE I FILI
NEGLI APPOSITI
CANALI

CURSORE TENDIFILO

CURSORE ANGOLARE

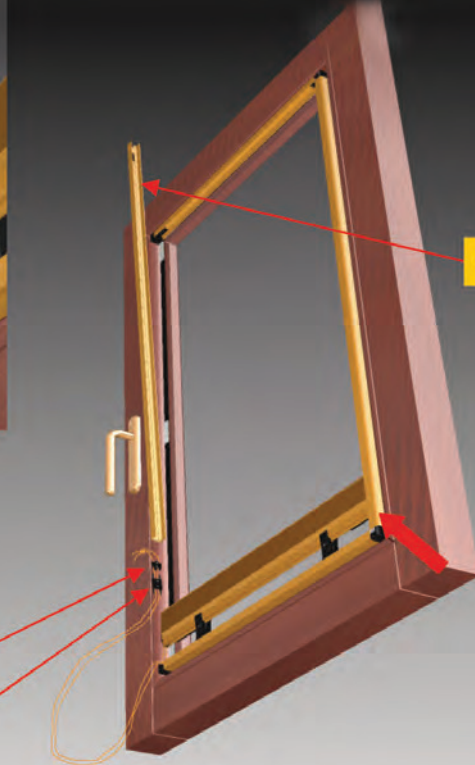

GUIDA SX

INSERIRE I
CURSORI A
SINISTRA
NELLA
GUIDA SX

**FARE SCORRERE I
CORSORI
ALL'INTERNO
DELLA GUIDA SX**

**TENERE IN
TENSIONE I
FILI**



**TENERE IN
TENSIONE I
FILI**

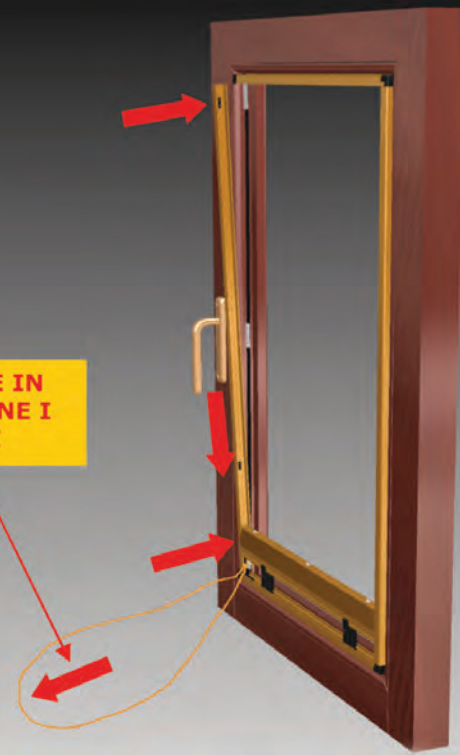

**INSERIRE LA
GUIDA SX SUL
BARRAMANIGLIA
E FISSARLA**

**TOGLIERE LA
PROTEZIONE
SULL'ADESIVO
DEL VELCRO
CENTRALE**

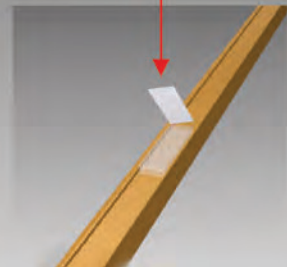

**INSERIRE IL
CURSORE
ANGOLARE**

CURSORE ANGOLARE

SERRARE LE VITI

**LIBERARE IL TESSUTO E FISSARLO
AL MONTANTE DI PARTENZA**

I FILI RIENTRANO IN SEDE

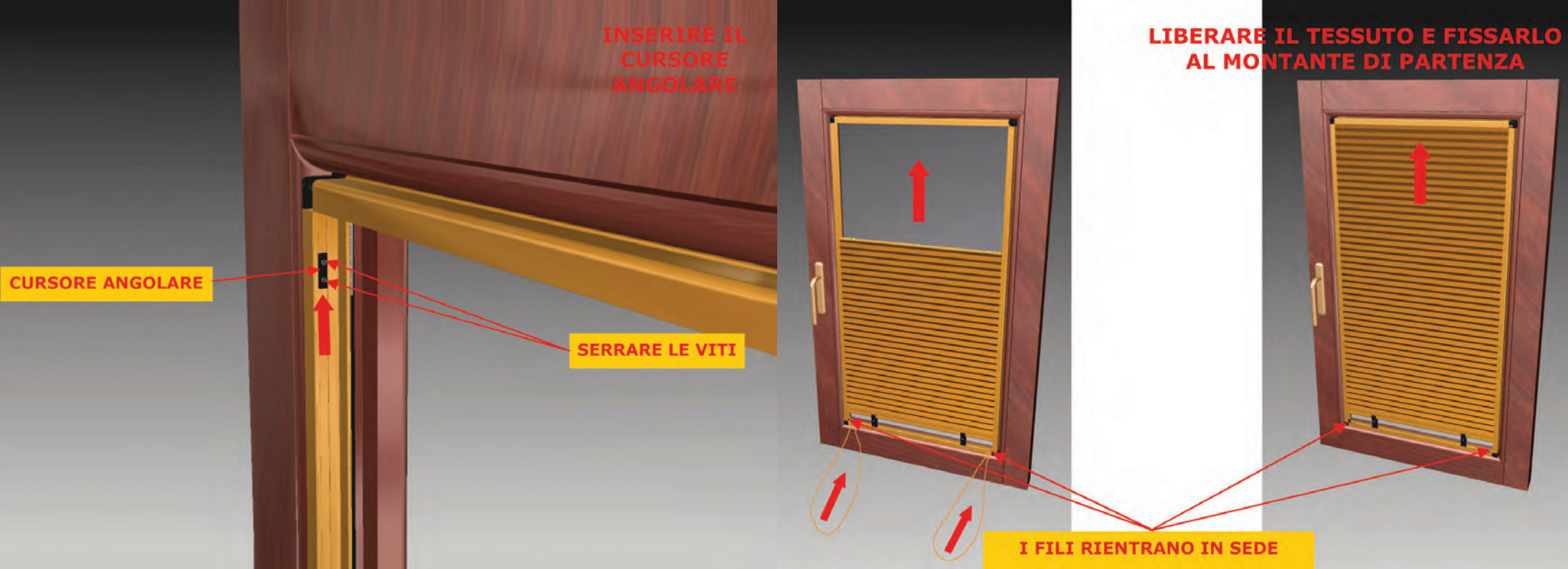

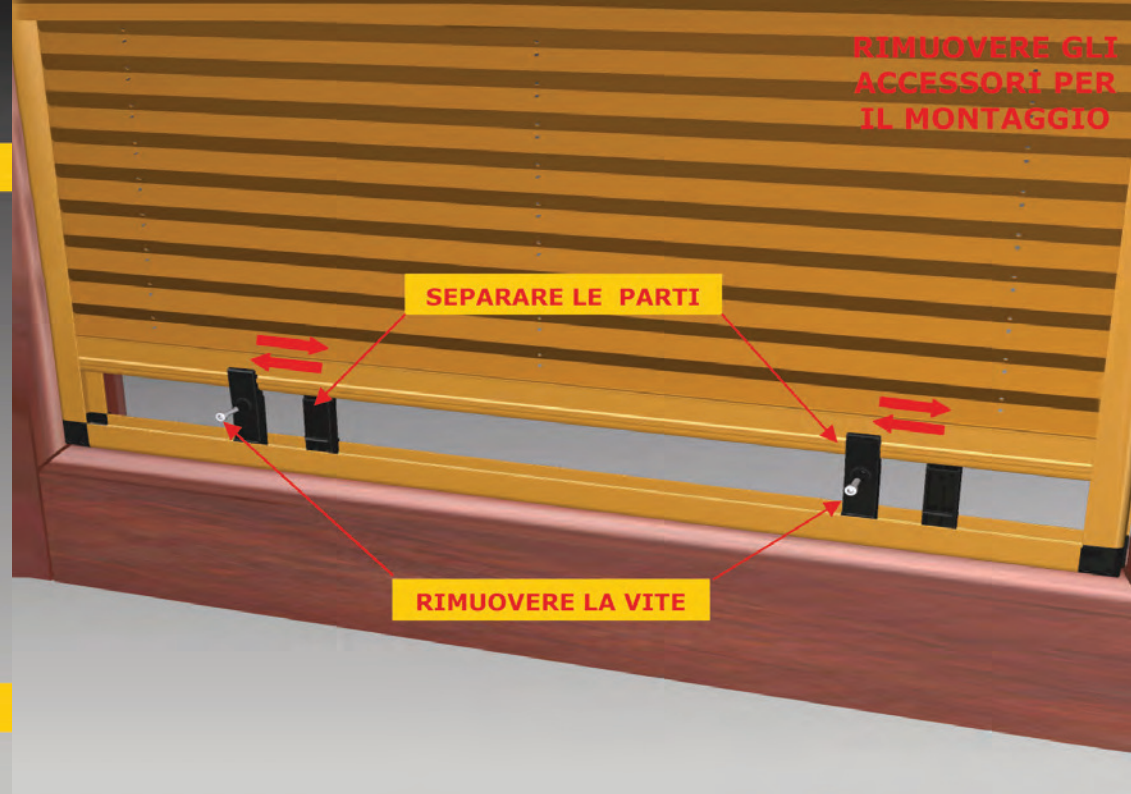
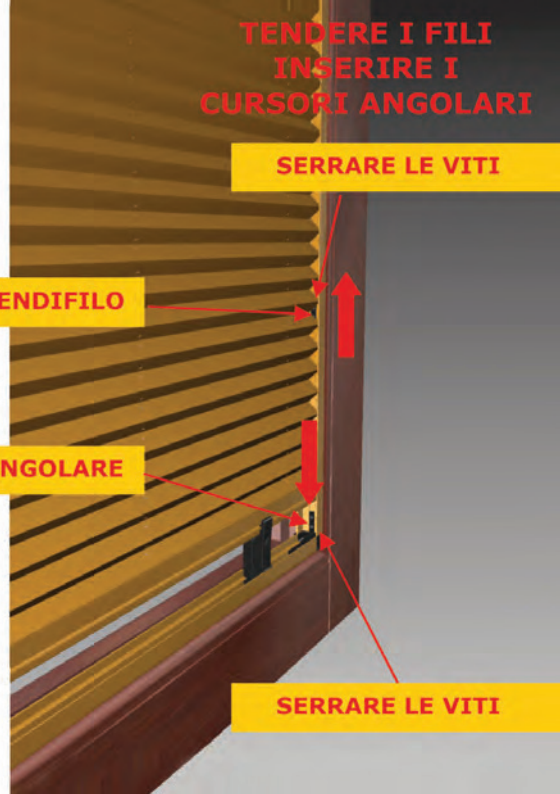
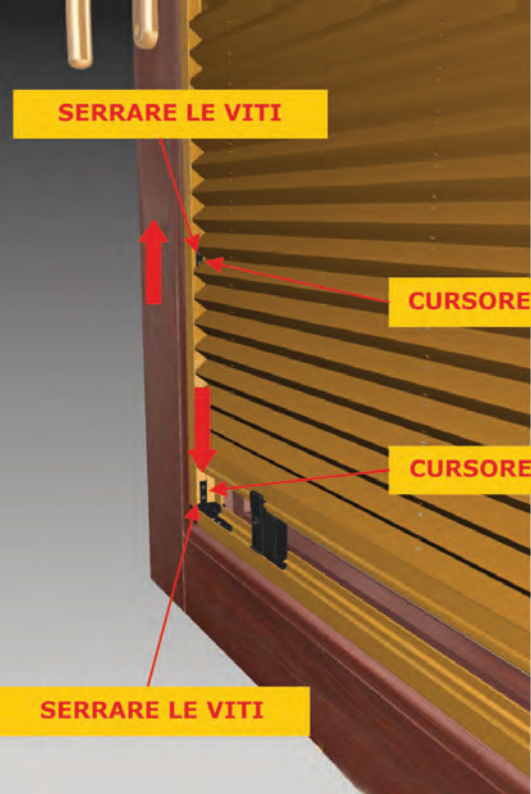

PROVA LA TENDA



**INSERISCI IL
PROFILO DI
RISCONTRO**

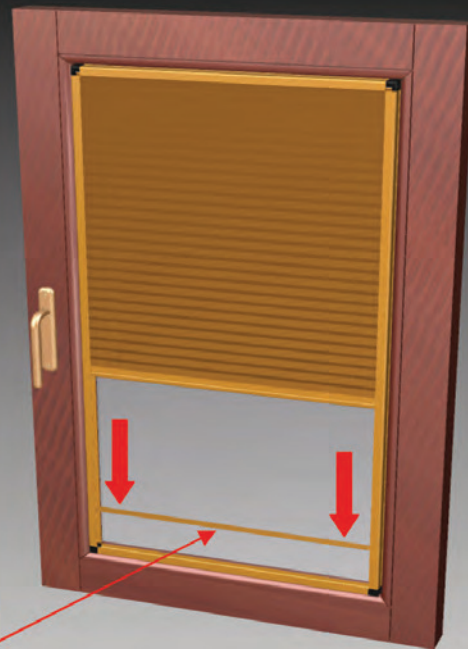

**PROFILO DI
RISCONTRO**

PROVARE LA TENDA E SE NECESSARIO REGOLARE DI NUOVO LA TENSIONE DEI FILI

**COPERTURA
ANGOLARE**

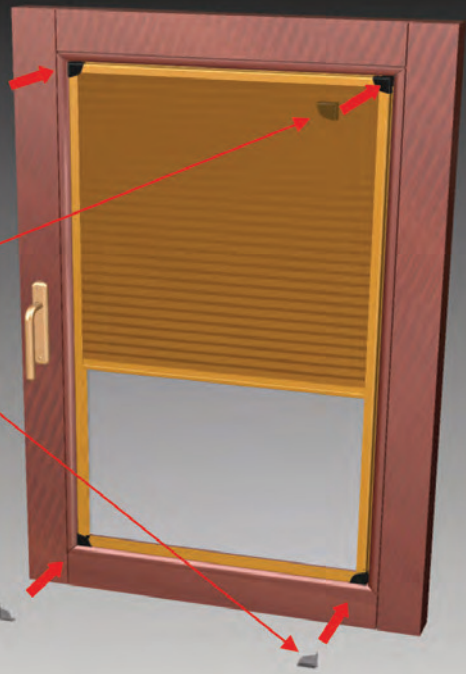

**INSERISCI LE
COPERTURE
ANGOLARI**

ESPLOSO

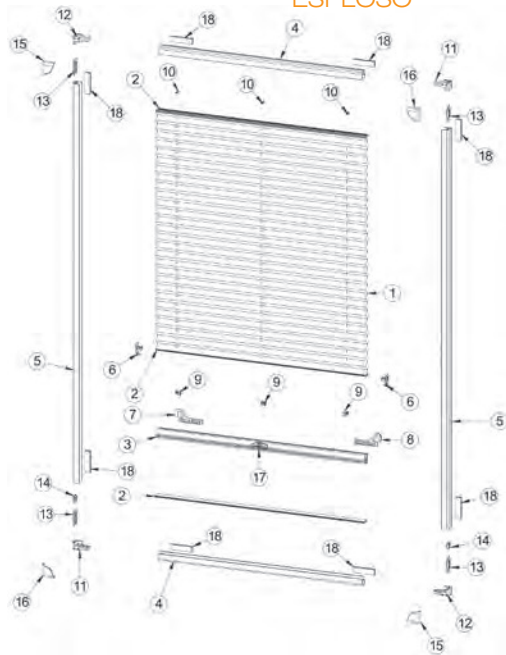

- 1] Fabric
- 2] Fabric Profile
- 3] Bar Handle
- 4] Starting / Ending Profile
- 5] Track
- 6] End Pulley
- 7] Sliding block LPO 1
- 8] Sliding block LPO 2
- 9] Central Pulley
- 10] Cord Lock
- 11] Corner Piece
- 12] Corner Pointer
- 13] Cord Lock Pointer
- 14] Corner Cover
- 15] Corner Cover 1
- 16] Handle
- 17] Velcro
- 18] Fabric

SEZIONI E INGOMBRI

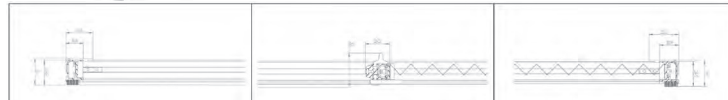

DFM

INNOVAZIONE & DESIGN

DFM srl - via Thomas Edison 19
00015 Monterotondo - Roma
Tel +39 06 906 94 23 r.a.
Fax +39 06 906 03 01 - info@dfmitalia.com
www.dfmitalia.com - www.lapliss.it

