

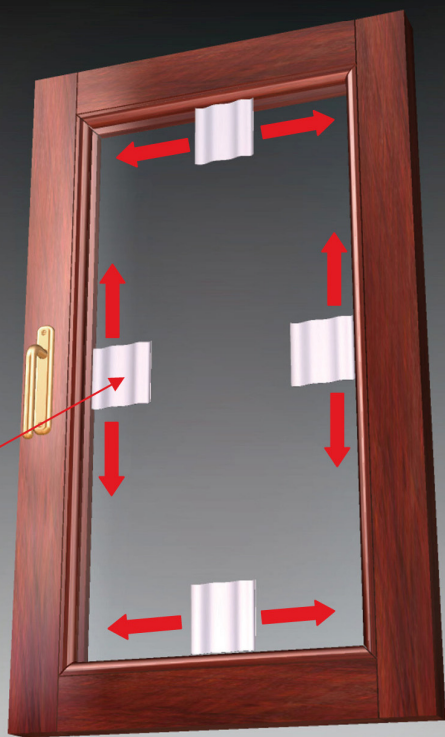

Per problemi in sede di montaggio potete contattare il ns call center al numero +39 06 906 94 23 oppure visitare il nostro sito, [www.dfmitalia.com](http://www.dfmitalia.com), sezione supporto, domande frequenti.  
Per ulteriori info scriveteci a [info@dfmitalia.com](mailto:info@dfmitalia.com)



**SALVIETTINA 3M  
IN DOTAZIONE**



**PULIRE IL VETRO**

**FILM ADESIVO IN  
DOTAZIONE**

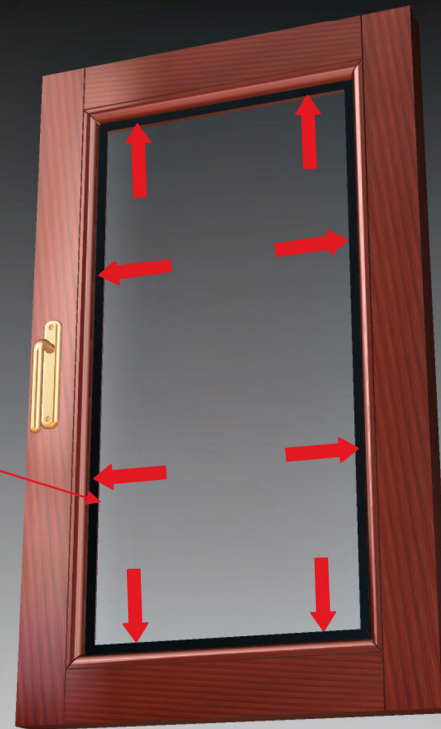

**FISSARE IL FILM  
ADESIVO**

**ALLINEARE IL  
MONTANTE DI  
PARTENZA CON I  
MARGINI DEL  
VETRO**

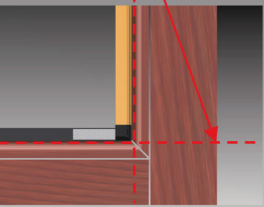

**FISSARE IL  
MONTANTE DI  
PARTENZA**

**TOGLIERE LA  
PROTEZIONE  
SUL'ADESIVO  
DEL VELCRO  
CENTRALE**

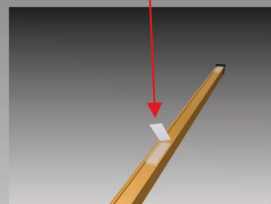

**DIMA DI FISSAGGIO**

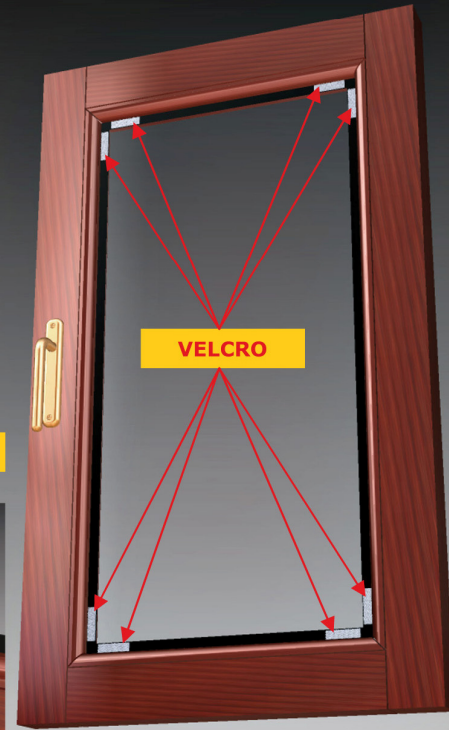
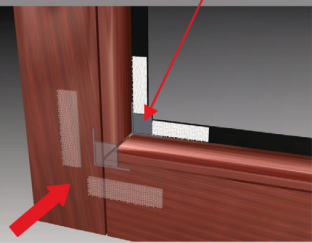

**VELCRO**

**FISSARE IL VELCRO**

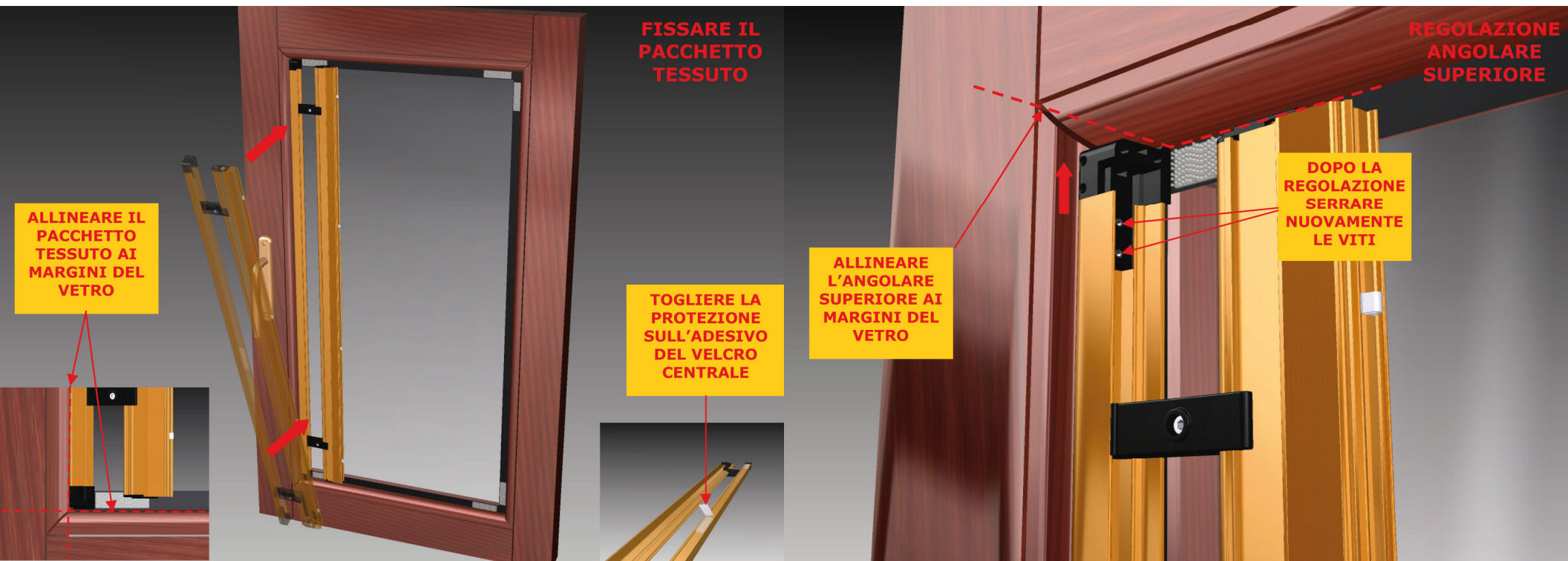

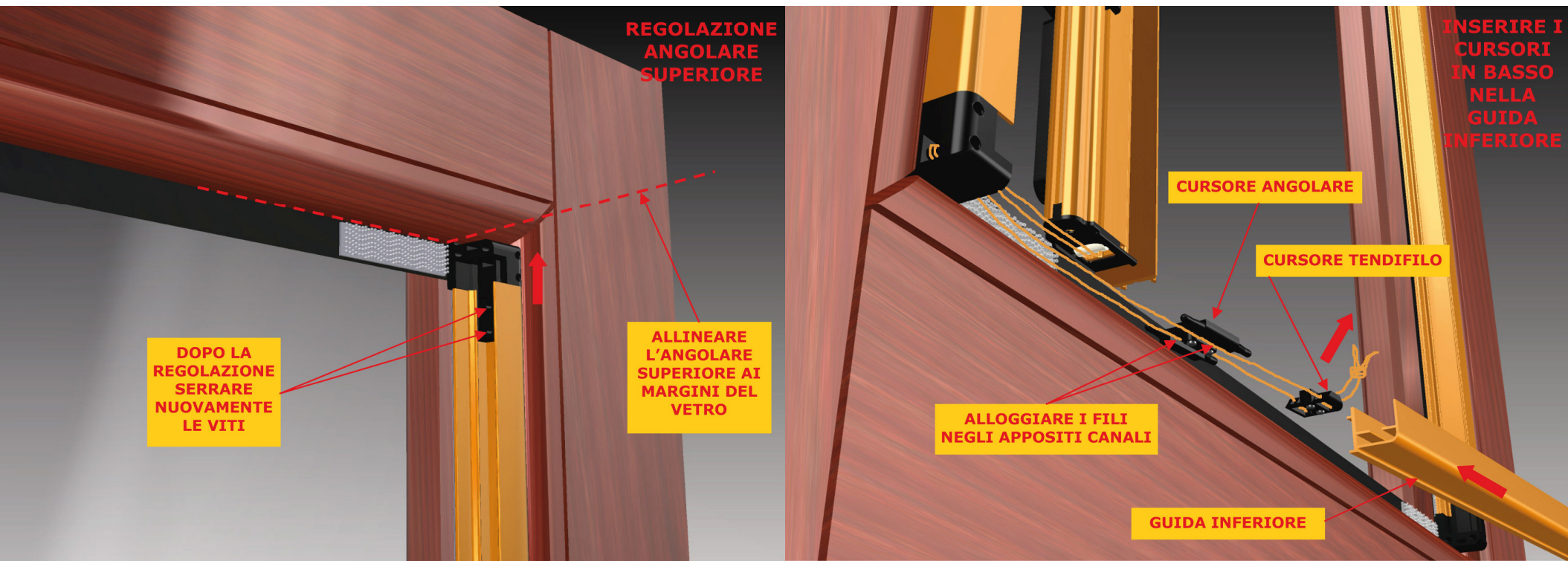

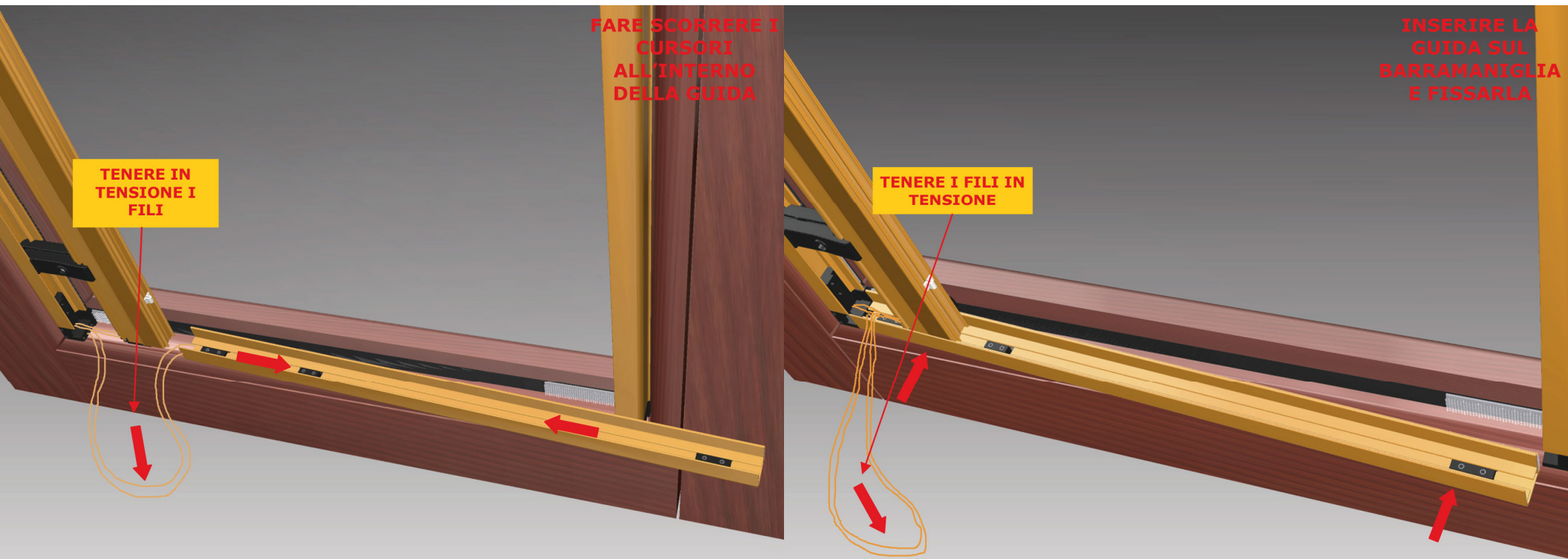

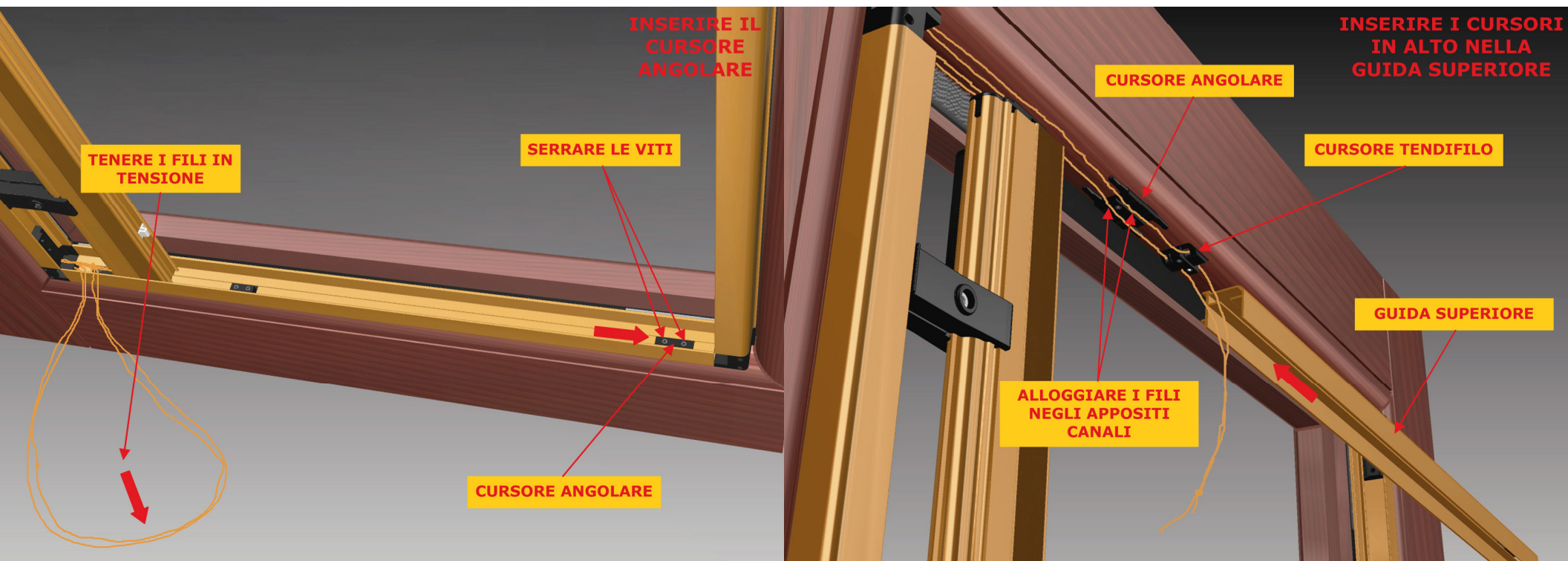

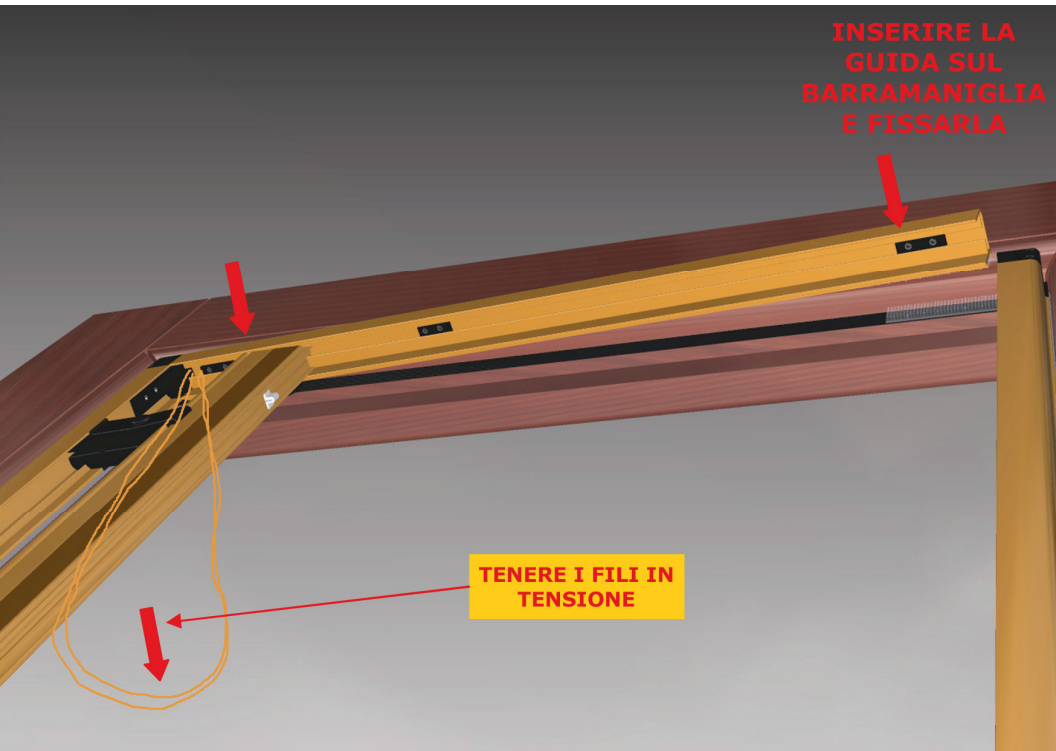
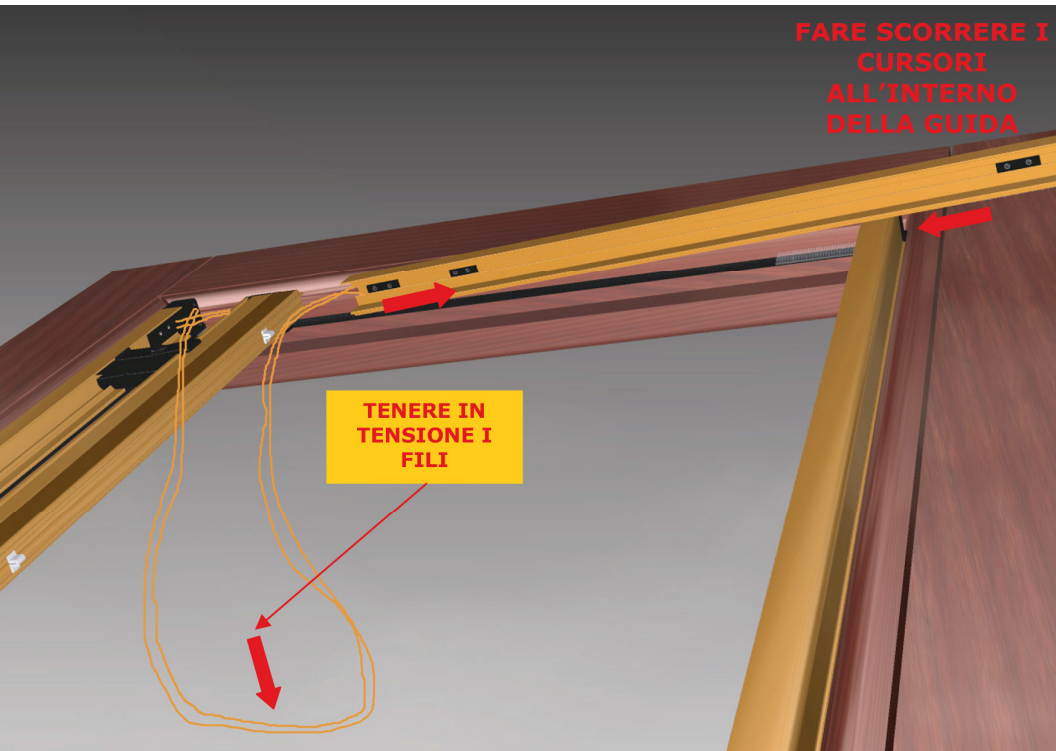



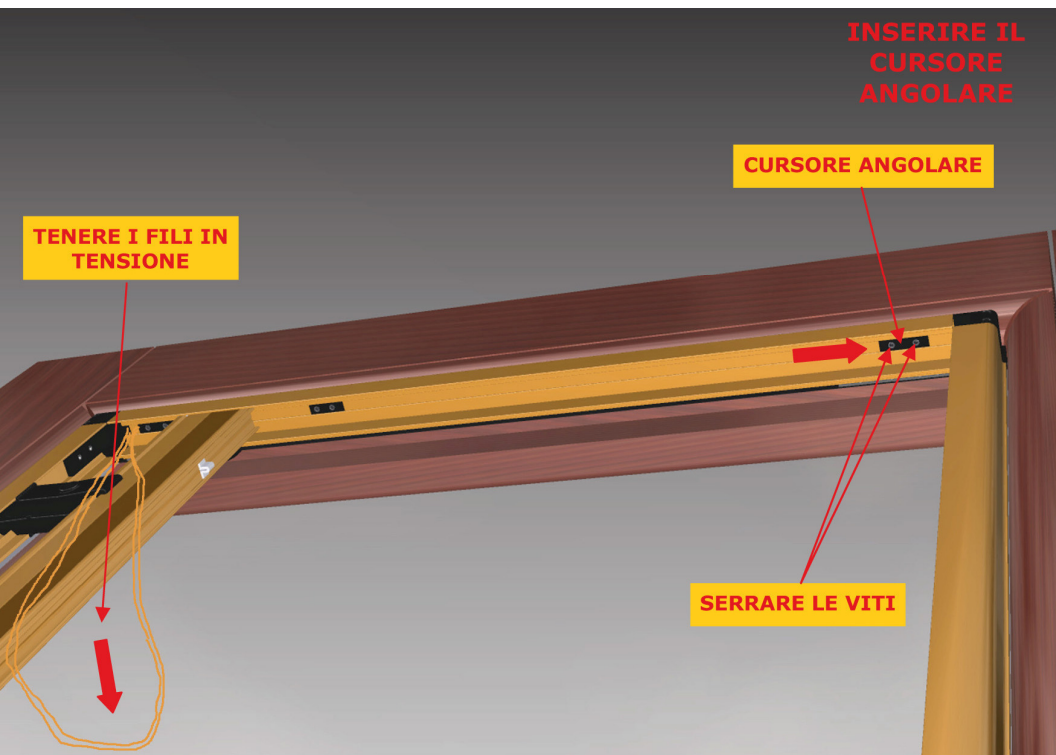

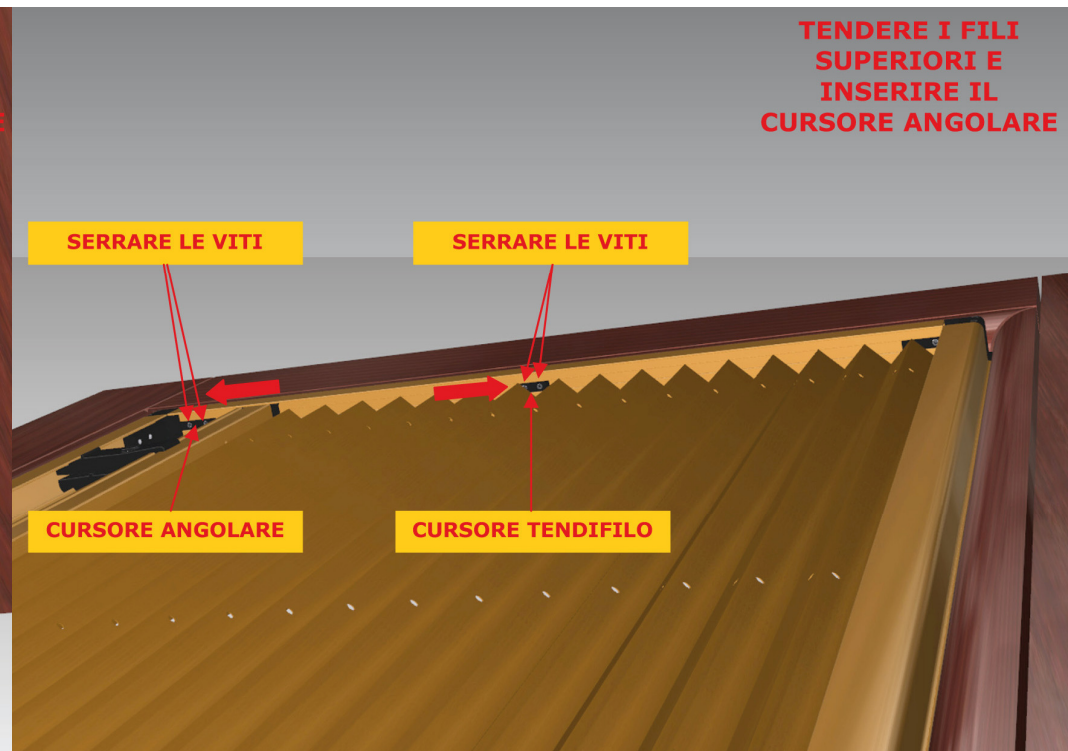
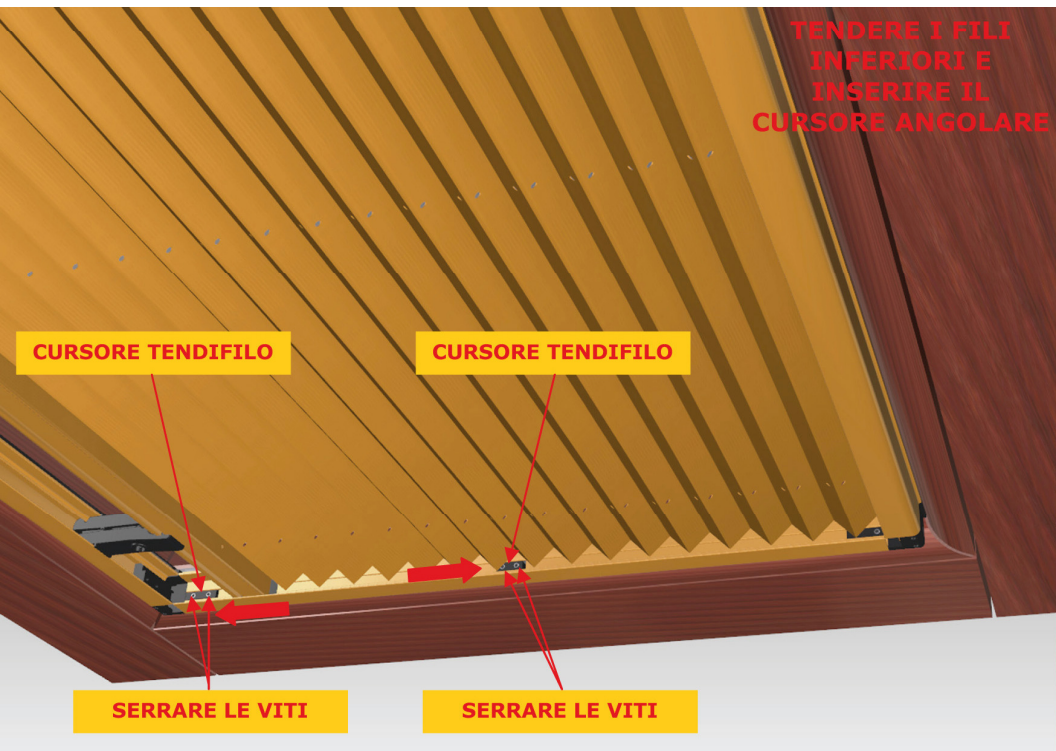

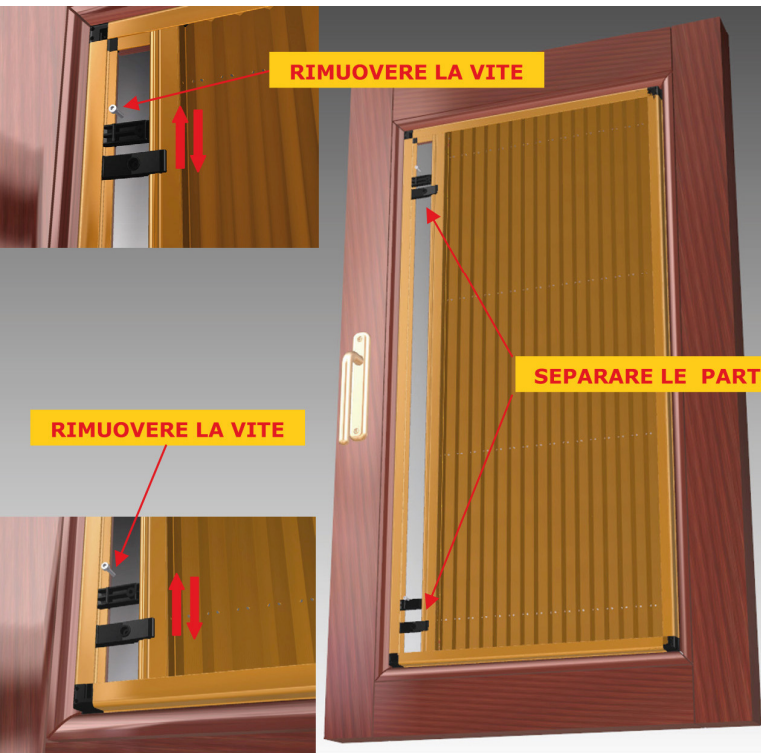

**RIMUOVERE GLI ACCESSORI PER IL MONTAGGIO**

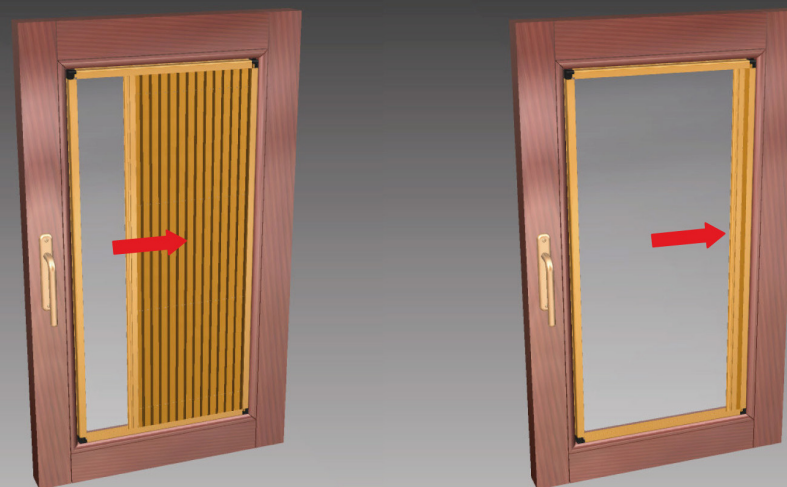

**INSERISCI IL  
PROFILO DI  
RISCONTRO**

**PROFILO DI  
RISCONTRO**

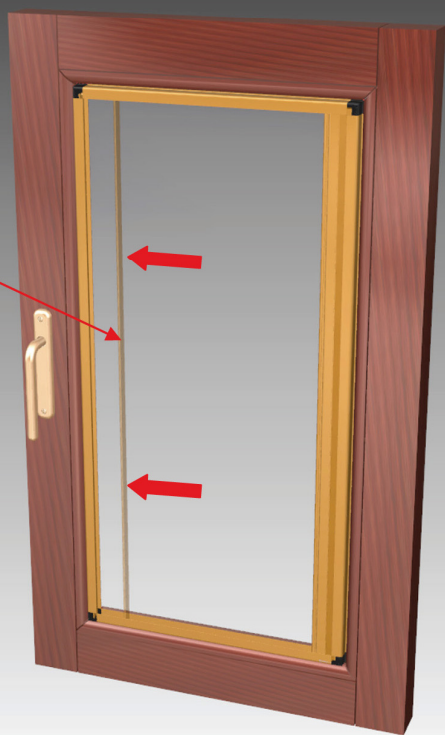

**INSERISCI LE  
COPERTURE  
ANGOLARI**

**COPERTURA  
ANGOLARE**

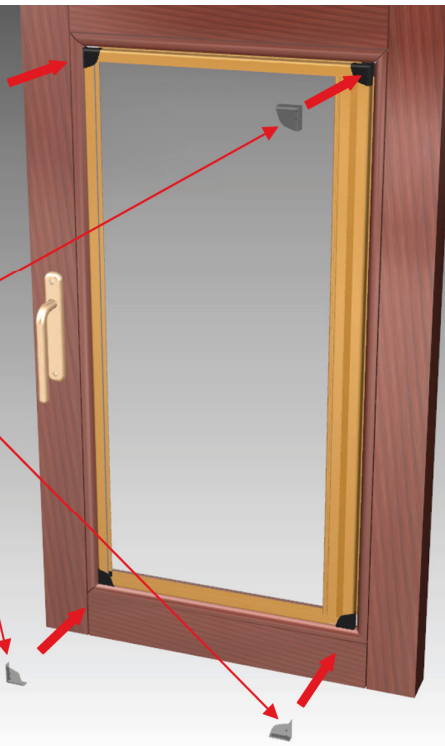

**DFM**

INNOVAZIONE & DESIGN

DFM srl – via Thomas Edison 19  
00015 Monterotondo - Roma  
Tel +39 06 906 94 23 r.a.  
Fax +39 06 906 03 01 - info@dfmitalia.com  
[www.dfmitalia.com](http://www.dfmitalia.com) - [www.lapliss.it](http://www.lapliss.it)

